

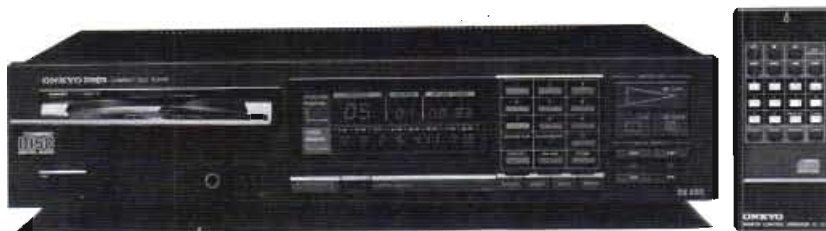

ONKYO® SERVICE MANUAL

COMPACT DISC PLAYER MODEL DX-200



UDN, UD	120V AC, 60Hz
UGV, UG	220V AC, 50Hz
UW	120/220V AC, 50/60Hz
UQA, UQB	240V AC, 50Hz

SAFETY-RELATED COMPONENT WARNING!!

COMPONENTS IDENTIFIED BY MARK  ON THE SCHEMATIC DIAGRAM AND IN THE PARTS LIST ARE CRITICAL FOR RISK OF FIRE AND ELECTRIC SHOCK. REPLACE THESE COMPONENTS WITH ONKYO PARTS WHOSE PARTS NUMBERS APPEAR AS SHOWN IN THIS MANUAL.

MAKE LEAKAGE-CURRENT OR RESISTANCE MEASUREMENTS TO DETERMINE THAT EXPOSED PARTS ARE ACCEPTABLY INSULATED FROM THE SUPPLY CIRCUIT BEFORE RETURNING THE APPLIANCE TO THE CUSTOMER.

SPECIFICATIONS

Type:	Compact Disc player with optical pickup
Quantization:	16 bit linear
Channels:	2 (Stereo)
Frequency response:	2Hz ~ 20kHz ±0.5dB
Dynamic range:	Over 96dB
Total harmonic distortion:	0.003% (1kHz)
Channel separation:	93 dB at 1kHz
S/N ratio:	Over 96dB
Wow and flutter:	Unmeasurable
Output:	2.0 volts
Pickup:	Semiconductor laser type
Power consumption:	21 watts
Dimensions:	435 (W) x 102 (H) x 350 (D) mm
Weight:	6.0kg
Accessories:	Connection cables Instruction manual Remote control

Specifications are subject to change without notice.



TABLE OF CONTENTS

Specifications	1
Precautions	2
Note on compact disc	3
Protection of eyes from laser beam during servicing	4
Laser warning labels	4
Cautions on replacement of pick-up	6
Packing view	7
Adjustment procedures	8
Exploded view	11
Mechanism exploded view	13
Parts list	14
PC board view/parts list	16
Preamp/Headphone/Switches	16
Display/Power/Output/Indicator	17
Function switch	18
Main circuit	19

PRECAUTIONS

1. Removing the Transport Screws and Locking Plate

Three transport screws and locking plate are located on the bottom panel of this unit. Before using this unit for the first time, these screws and the plate must be removed. If power is switched on while these parts are still in place, the unit will not operate properly.

Note: For safe keeping, insert the short end of the locking plate back in the slot and replace the screw to hold the plate in place.

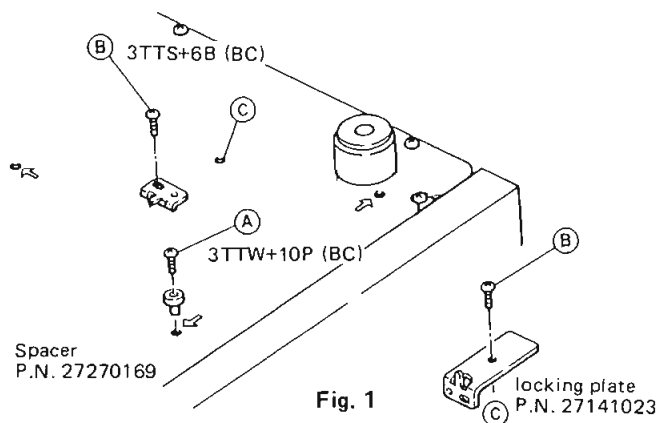

Fig. 1

2. Safety-check out (U.S.A. model)

After correcting the original service problem, perform the following safety check before releasing the set to the customer:

Connect the insulating-resistance tester between the plug of power supply cable and chassis.

Specifications: more than 10Mohm at 500V.

3. Replacing the fuses

For continued protection against fire hazard, replace only with same type and same rating fuse.

Circuit no.	Part no.	Description
F801	252063	500mA-EAWK, Primary (G/Q models)
F802	252063	500mA-EAWK, Primary (W model)
F801	252045	1A (ST-6), Primary (D/W models)

4. Procedures for replacement of flat packaged ICs

1. Tools to be used:

- (1) **Soldering iron** Grounded soldering iron or soldering iron with leak resistance of 10 Mohms or more.

Form of soldering iron's tip:

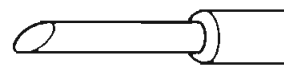

Fig. 2

- (2) **Magnifying glass** for checking of finished works
- (3) **Tweezers** for handling of IC and forming of leads
- (4) **Grounding ring** Countermeasure for electrostatic breakdown
- (5) **Nipper** for removing defective IC
- (6) **Small brush** for application of flux

2. Work Procedures:

(1) Remove the defective IC

Cut all leads of the defective IC one by one using a nipper and remove the IC.

(2) Clean the pattern surface of the PC board.

Get rid of the remaining leads and solder.

(3) Check and form the leads of the new flat packaged IC to be installed.

From every lead on the new IC using a pair of tweezers, so that all of them are aligned neatly without being risen, twisted or inclined toward one side. Especially the rising portion of every lead must be formed with greatest care.

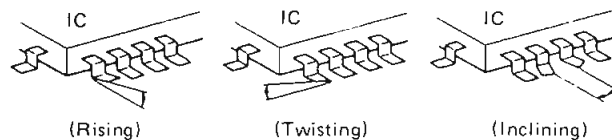
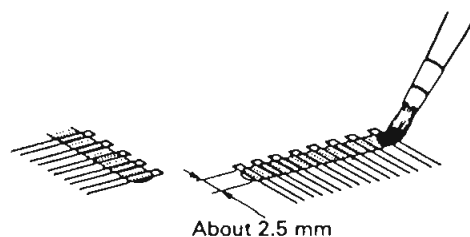

Fig. 3

(4) Apply flux to the PC board.

Apply flux to the pattern surface of the PC board which has been cleaned, as shown in the illustration. The area to be applied with flux is the portion of about 2.5mm in width where the IC's leads are to be soldered.

Be careful to apply minimum amount of flux required so as not to smear it on unwanted areas.



(5) Temporarily tighten the IC

Carefully align the pattern and IC's leads, so that the IC will be temporarily tightened to the pattern on the four leads at the corners. At this time, soldering is required, but no need to apply soldering material.

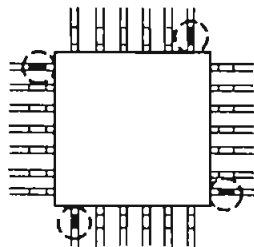

Fig. 5

(6) Apply flux to IC's leads

Apply flux to the areas of IC's leads where soldering is to be performed. Be careful not to smear flux on the root portion of any lead or the body of IC.

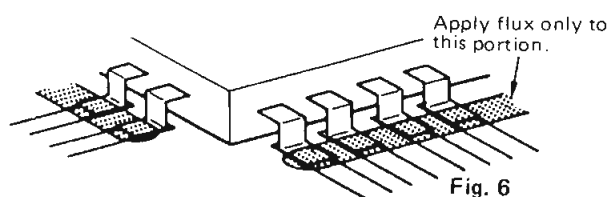

Fig. 6

(7) Soldering

While attaching the tip of the soldering iron to the soldering point as shown in the illustration, feed 2–5mm of soldering wire. Then, slowly move the iron in the direction indicated by the arrow in the illustration, so that the leads will be soldered to the pattern. Move the iron in the rate of approximately 1cm in 5sec. Proceed with your work while confirming a clean fillet of solder is formed on each lead, subsequent to the melting of flux.

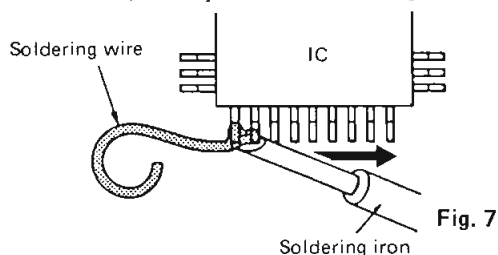

Fig. 7

CAUTION

- 1) If you move the iron too quickly, loose soldering is likely to result.
 - 2) Be especially careful when soldering the first lead where loose soldering is most liable to be formed.
- (8) Check the results**

When soldering of all leads is finished, check the soldered portion on every lead with a magnifying glass. A tester must not be used or checking of any soldered position

NOTE ON COMPACT DISC**• Holding Compact Discs**

Hold Compact Discs by the edges so that you do not touch

the surface of disc. Remember that the side of the disc with the "rainbow" reflection is the side containing the audio information.

Do not attach tape or paper to the label side of the disc and always be careful not to leave fingerprints on the side that is played.

• Storing Compact Discs

Store Compact Discs in a location protected from direct sunlight, high heat and humidity and extremely high and low temperatures. Discs should never be left in the trunk or interior of an automobile in the sun since the temperature can become very high in such a closed environment.

Always store Compact Discs in the holders in which they were sold. Never leave a disc in the player's disc holder for a long period of time.

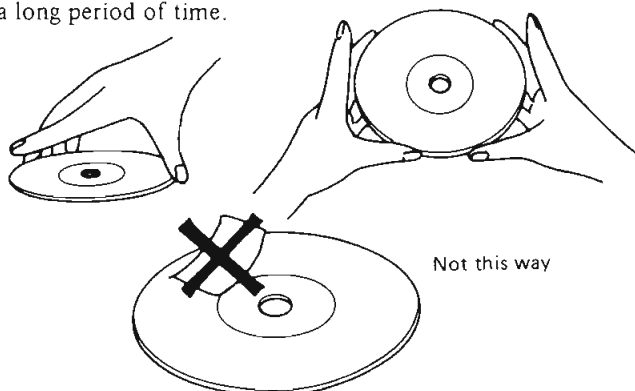
**• Cleaning Compact Discs**

Before playing a disc wipe off the playing surface with a soft cloth to remove dust and other soil. Wipe the surface in straight lines from the center of the disc outward, not in a circular motion as you would with a phonograph record.

Do not use benzene, chemical cleansers or phonograph record cleaning solutions to clean Compact Discs. Also avoid static electricity prevention solutions since they can damage the surface of Compact Discs.

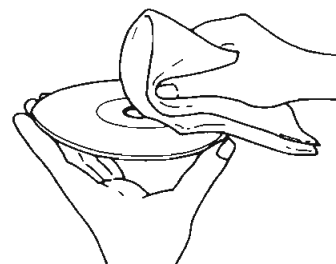
**Problems Caused by Dew**

Dew can form inside a Compact player when it is brought from a cold environment into a warm room, when a room is rapidly heated and if a player is left in a humid environment.

This dew can prevent the laser pickup from reading the data contained in the pits in the disc surface. If the player does not operate properly because of dew, remove the disc and leave the player's power switch on for about one hour to remove all moisture.

PROTECTION OF EYES FROM LASER BEAM DURING SERVICING

This set employs a laser. Therefore, be sure to follow carefully the instructions below when servicing.

WARNING!!

WHEN SERVICING, DO NOT APPROACH THE LASER EXIT WITH THE EYE TOO CLOSELY. IN CASE IT IS NECESSARY TO CONFIRM LASER BEAM EMISSION, BE SURE TO OBSERVE FROM A DISTANCE OF MORE THAN 30cm FROM THE SURFACE OF THE OBJECTIVE LENS ON THE OPTICAL PICK-UP BLOCK.

Laser Diode Properties

- Material: GaAs/GaAlAs
- Wavelength: 780nm
- Emission Duration: continuous
- Laser output: max. 0.4mW*

*This output is the value measured at a distance about 1.8mm from the objective lens surface on the Optical Pick-up Block.

LASER WARNING LABELS

The labels shown below are affixed.

1. Warning labels

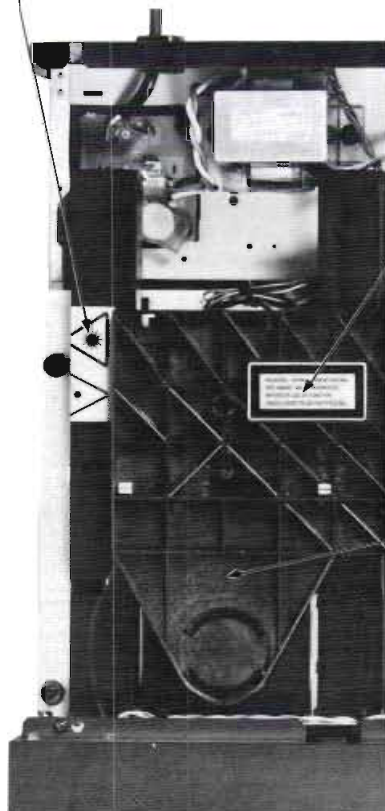
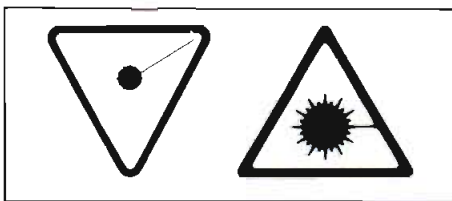

ADVARSEL: USYNLIG LASERSTRÅLING VED ÅBNING, NÅR SIKKERHEDSAF-BRYDER ER UDE AF FUNKTION. UNDGÅ UDSÆTTELSE FOR STRÅLING.

(Other models)

DANGER — INVISIBLE LASER RADIATION WHEN OPEN AND INTERLOCK FAILED OR DEFEATED. AVOID DIRECT EXPOSURE TO BEAM.

CAUTION — HAZARDOUS LASER AND ELECTROMAGNETIC RADIATION WHEN OPEN AND INTERLOCK DEFEATED.

ATTENTION — RAYONNEMENT LASER ET ELECTROMAGNETIQUE DANGEREUX SI OUVERT AVEC L'ENCLANCHEMENT DE SECURITE ANNULE.

(UD model)

2. Certification label (UD model only)

This label is located on the back panel.

PRODUCT IS CERTIFIED BY THE MANUFACTURER TO COMPLY WITH DHHS RULES 21 CFR SUBCHAPTER J APPLICABLE AT THE DATE OF MANUFACTURE.

MANUFACTURED: 1985

3. Class 1 label (UG/UW/UQ models)

This label is located on the back panel.



ADVARSEL

"CLASS 1 LASER
PRODUCT"

Denne mærkning er anbragt på apparatets højre side og indikerer, at apparatet arbejder med laserstråler af klasse 1, hvilket betyder, at der anvendes laserstråler af svageste klasse, og at man ikke på apparatets yderside kan blive udsat for utilladelig kraftig stråling.

APPARATET BØR KUN ÅBNES AF FAGFOLK MED SÆRLIGT KENDSKAB TIL APPARATER MED LASERSTRÅLER!

ADVARSEL: USYNLIG LASERSTRÅLING
VED ÅBNING. NÅR SIKKERHEDSAF-
BRYDER ER UDE AF FUNKTION,
UNDGA UDSÆTTELSE FOR STRÅLING.

Indvendigt i apparatet er anbragt den her gengivne advarselmærkning, som advarer imod at foretage sådanne indgreb i apparatet, at man kan komme til at udsætte sig for laserstråling.

CAUTIONS ON REPLACEMENT OF PICK-UP

The laser diode in the optical pick-up block is so sensitive to static electricity, surge current and etc. that the components are liable to be broken down or its reliability remarkably deteriorated.

During repair, carefully take the following precautions.

(The following precautions are included in the service parts.)

PRECAUTIONS

1. Ground for the work-desk.

Place a conductive sheet such as a sheet of copper (with impedance lower than $10^6\Omega$) on the work-desk and place the set on the conductive sheet so that the chassis.

2. Grounding for the test equipment and tools.

Test equipments and toolings should be grounded in order that their ground level is the same the ground of the power source.

3. Grounding for the human body.

Be sure to put on a wrist-strap for grounding whose other end is grounded.

Be particularly careful when the workers wear synthetic fiber clothes, or air is dry.

4. Select a soldering iron that permits no leakage and have the tip of the iron well-grounded.

5. Do not check the laser diode terminals with the probe of a circuit tester or oscilloscope.

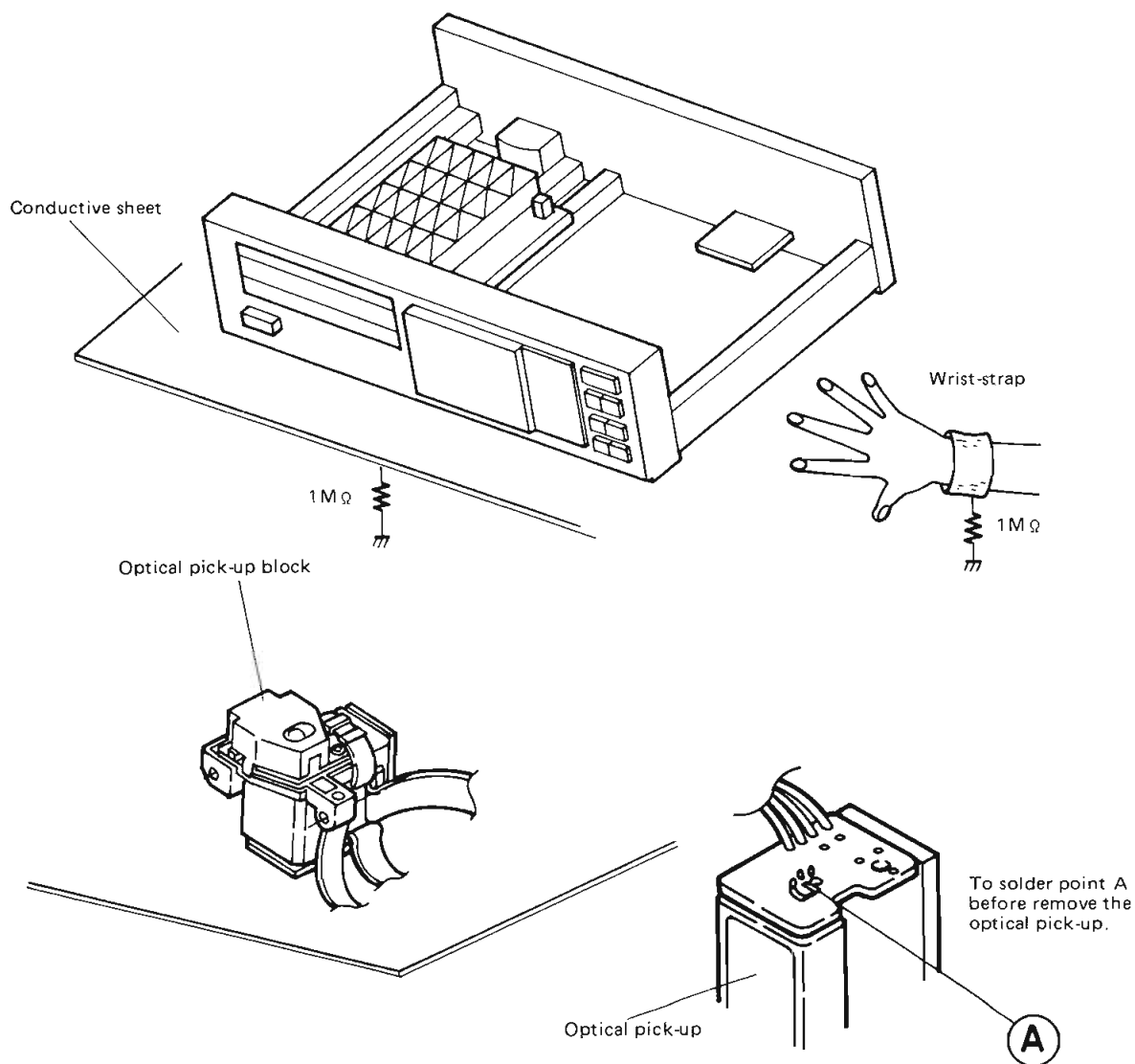

PACKING VIEW

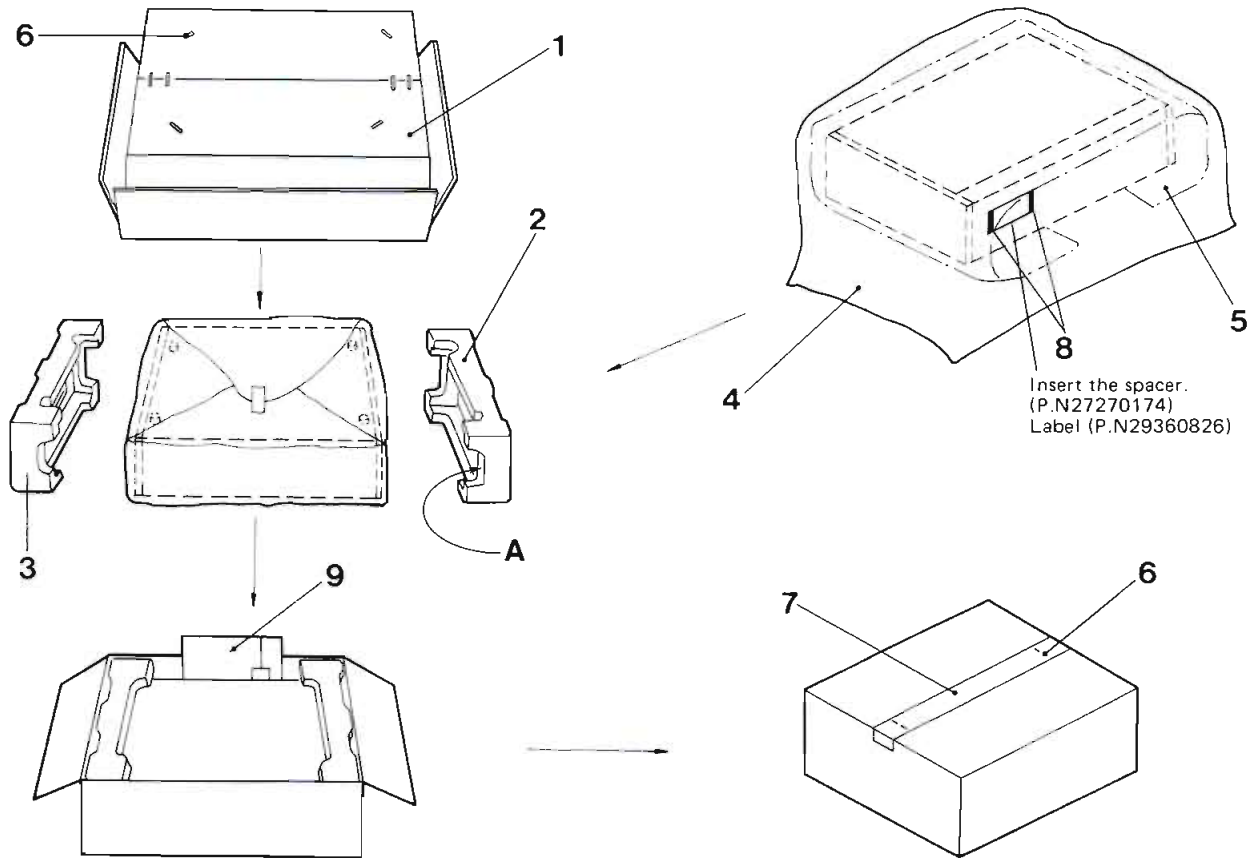

REF. NO.	PART NO.	DESCRIPTION
1	29051128	Master carton box
2	29090622A	Pad, left
	29090992	Pad (Paste on back A of pad, left)
3	29090623B	Pad, right
4	29100036A	550 × 850mm, Poly-vinyl bag
5	2909512-1	500 × 800mm, Protection sheet
6	282301	Sealing hook
7	260012	50 × 700mm, Damplon tape
8	29095407	Sheets
9	Accessory bag ass'y (120V model)	
	29340884	Instruction manual
	2010097	Connection cable
	241052	Remote control unit
	29100006	350 × 250mm, Polyvinyl bag
	29365006-7	Warranty card (DN)
	29358002C	Service station list (DN)

PART NO.	DESCRIPTION
(220/240V models)	
29340885	Instruction manual
2010097	Connection cable
241052	Remote control unit
29100006	350 × 250mm, Polyvinyl bag (West Germany model)
29340885	Instruction manual
2010097	Connection cable
241052	Remote control unit
29100006	350 × 250mm, Polyvinyl bag
29365016	Warranty card (Universal model)
29340885	Instruction manual
2010097	Connection cable
241052	Remote control unit
29100006	350 × 250mm, Polyvinyl bag
25055040	CV-K-2, Conversion plug

(DN): Only U.S.A. model

ADJUSTMENT PROCEDURES

1. CLV-PLL circuit adjustment

Instrument Required: Frequency counter, adjusting rod, shorting clip

- (1) Turn on power to set.
- (2) With set in STOP condition, use shorting clip to drop VC01 (TP-221) to ground.
- (3) Connect frequency counter to WFCK (TP-283).
- (4) Turn the OSC coil L206 to adjust frequency to 7.35 ± 0.01 kHz.
- (5) Remove shorting clip.

2. Focus tracking adjustment

- Set the semi-fixed resistors R114, R226, R229, R232 to about their midpoint.
- Carry out adjustment at Track 1. Take sufficient care to avoid damage.

2-1 Adjustment method – I (when using adjustment jig [1])

Instrument Required: Adjustment jig [1], standard disc (SONY TEST CD Type 4 (YEDS-18))

- Turn on power to adjustment jig [1], and after turning on SW1, insert connectors P207 and P208.

2-1-1 Focus offset adjustment

- (1) Turn on SW1 of adjustment jig [1].
- (2) With meter 2 in the range of $0 \pm 0.1V$, adjust R229 for minum deflection of meter 1.

Note: When the deflection of meter 1 is broad, adjust meter 2 to 0V.

2-1-2 Focus gain adjustment

- (1) Turn on SW2 of adjustment jig [1].
- (2) Adjust R232 until the deflection of meter 1 is 0.10V. (If R232 is turned clockwise, the deflection of meter 1 reduces.)
- (3) At this time, check to see that meter 2 reads in the range of $0 \pm 0.1V$.
- (4) If meter 2 is outside the range of $0 \pm 0.1V$, return to the adjustment of 2-1-1.

2-1-3 Tracking offset adjustment

- (1) Turn on SW3 of adjustment jig [1].
- (2) Set R226 to Min. (Completely counterclockwise)
- (3) Adjust R114 to bring the deflection of meter 2 to the center.

Note: 1. When the disc rotates at high speed, make the adjustment while holding down the speed manually.
2. An adjusting rod of insulating material must be used.

2-1-4 Tracking gain adjustment

- (1) Return R226 to about the center, and confirm that the servo is operating.
- (2) Turn on SW4 of the adjustment jig [1].
- (3) Adjust R226 so that meter 1 deflects to 0.10V. (If R226 is turned clockwise, meter 1 deflection reduces.)

2-1-5 Disconnection of adjustment jig [1].

- (1) Turn on SW1 of adjustment jig [1].
- (2) Remove connectors P207 and P208 of adjustment jig [1].

2-2 Adjustment method – II (when adjustment jig [2] is used)

Instrument Required: Adjustment jig 2, standard disc (SONY TEST CD Type 4 (YEDS-18)), oscilloscope, CR oscillator, DC voltmeter.

2-2-1 Focus offset adjustment

- (1) Connect DC voltmeter to terminal FE (TP-207).
 - (2) Connect oscilloscope to terminal EYE (TP-209).
 - (3) With terminal FE within the range of $0 \pm 0.25V$, observe the waveform on the oscilloscope, and adjust R229 for the least jitter.
- When the amount of jitter is broad, adjust FE to 0V.

2-2-2 Focus gain adjustment

- (1) Apply a sine wave of 6 V p-p at 500Hz from the CR oscillator to terminal 1 of adjustment jig [2].
- (2) Connect the oscilloscope to terminal 2 of adjustment jig [2].
- (3) Turn on SW1 of adjustment jig [2].
- (4) Adjust R232 so that there is a sine wave of 1V p-p on the oscilloscope. (If there are 2 images on the oscilloscope, it is better to remove the synch from the oscillator output.)
- (5) After adjustment, disconnect the oscillator.

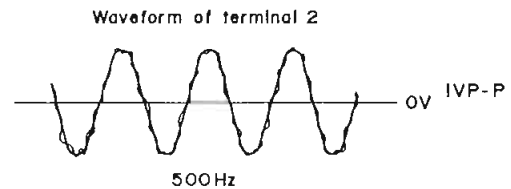

2-2-3 Tracking offset adjustment

- (1) Connect the oscilloscope to terminal TE (TP-206).
- (2) Set R226 to Min. (completely counterclockwise).
- (3) Adjust R114 so that the waveform deflection at TE is 0V at the center.

Note: 1. When the disc rotates at high speed, make the adjustment while holding down the speed manually.
2. An adjusting rod of insulating material must be used.



2-2-4 Tracking gain adjustment

- (1) Return R226 to about the center, and confirm that the servo is operating.
- (2) Connect the oscillator and oscilloscope to adjustment jig [2].
- (3) Turn on SW2 of adjustment jig [2].
- (4) In the same manner as that of 2-2-2, adjust R226 so that a sine wave of 1V p-p appears on the oscilloscope.

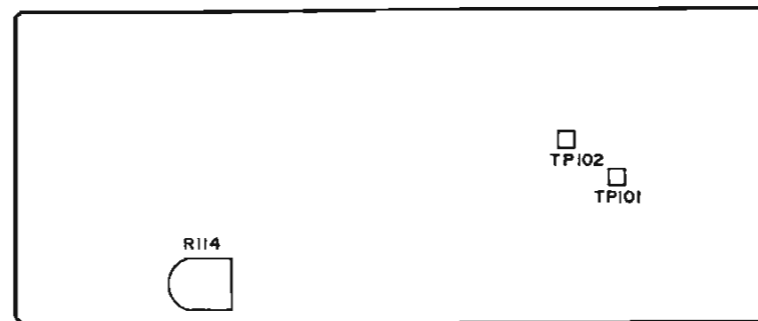
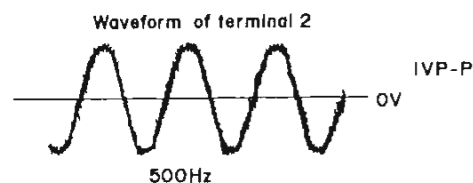

3. Remote Control Tuned Coil Adjustment

- (1) Connect the oscilloscope to IC Q501 pin 3.
- (2) Continue to press PLAY key of remote control transmit.
- (3) Keep away the distance of the transmit from unit so that peak-peak of waveform becomes 0.5V.
- (4) Adjust L501 so that waveform becomes maximum output.

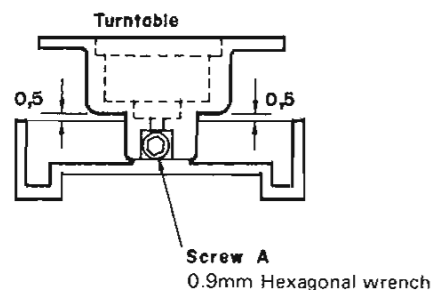

Mechanism Adjustment

• **Turntable height adjustment**

Adjust the screw A to make the gap between turntable and chassis M 0.5mm.

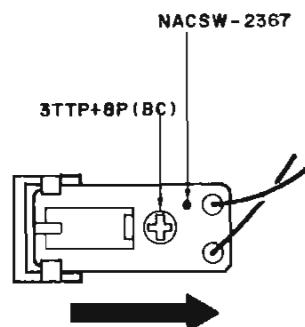

• **Close switch PC board attachment**

Attach the close switch PC board ass'y (NACSW-2367) to completely arrow mark.

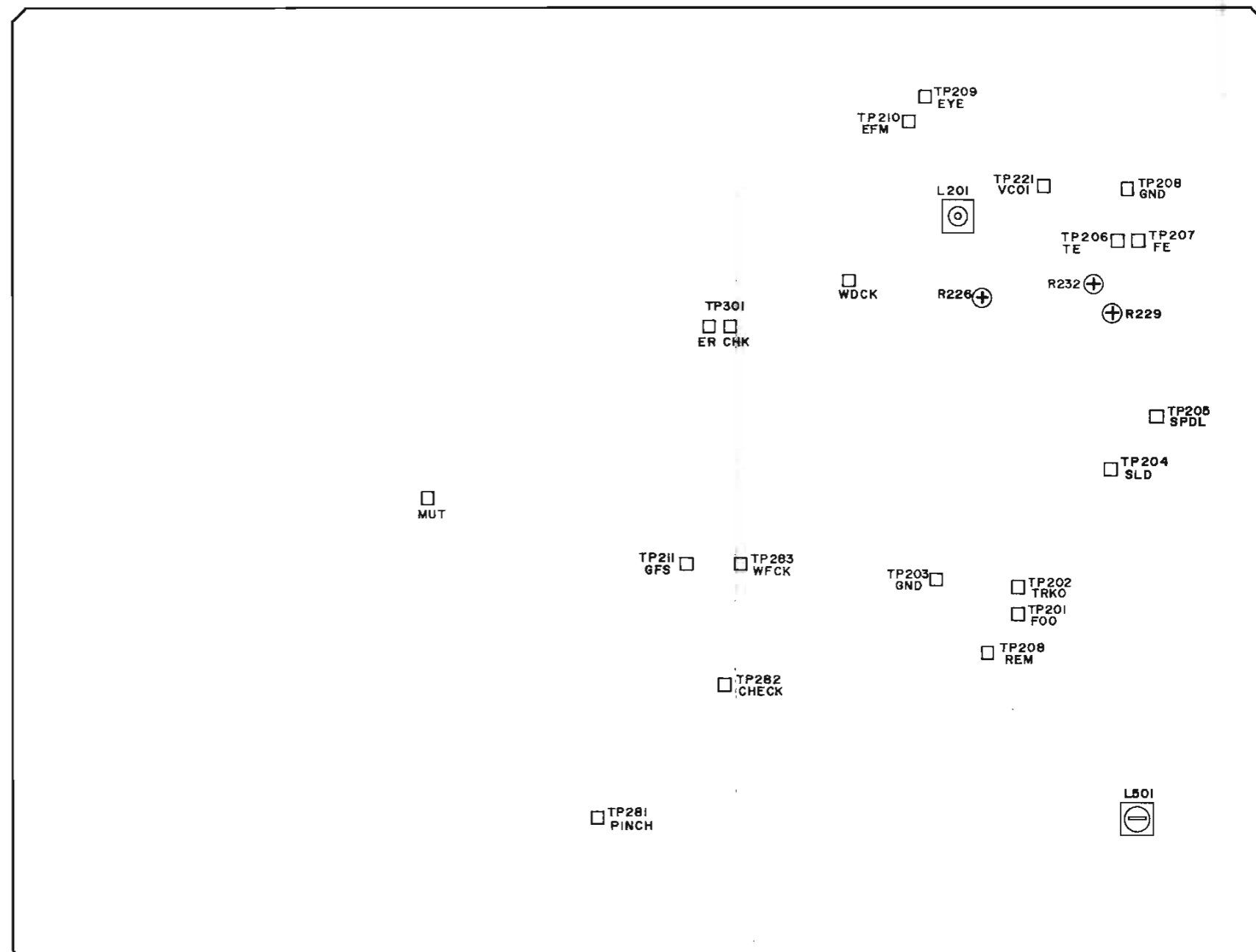

A

B

C

D

E

F

G

EXPLODED VIEW

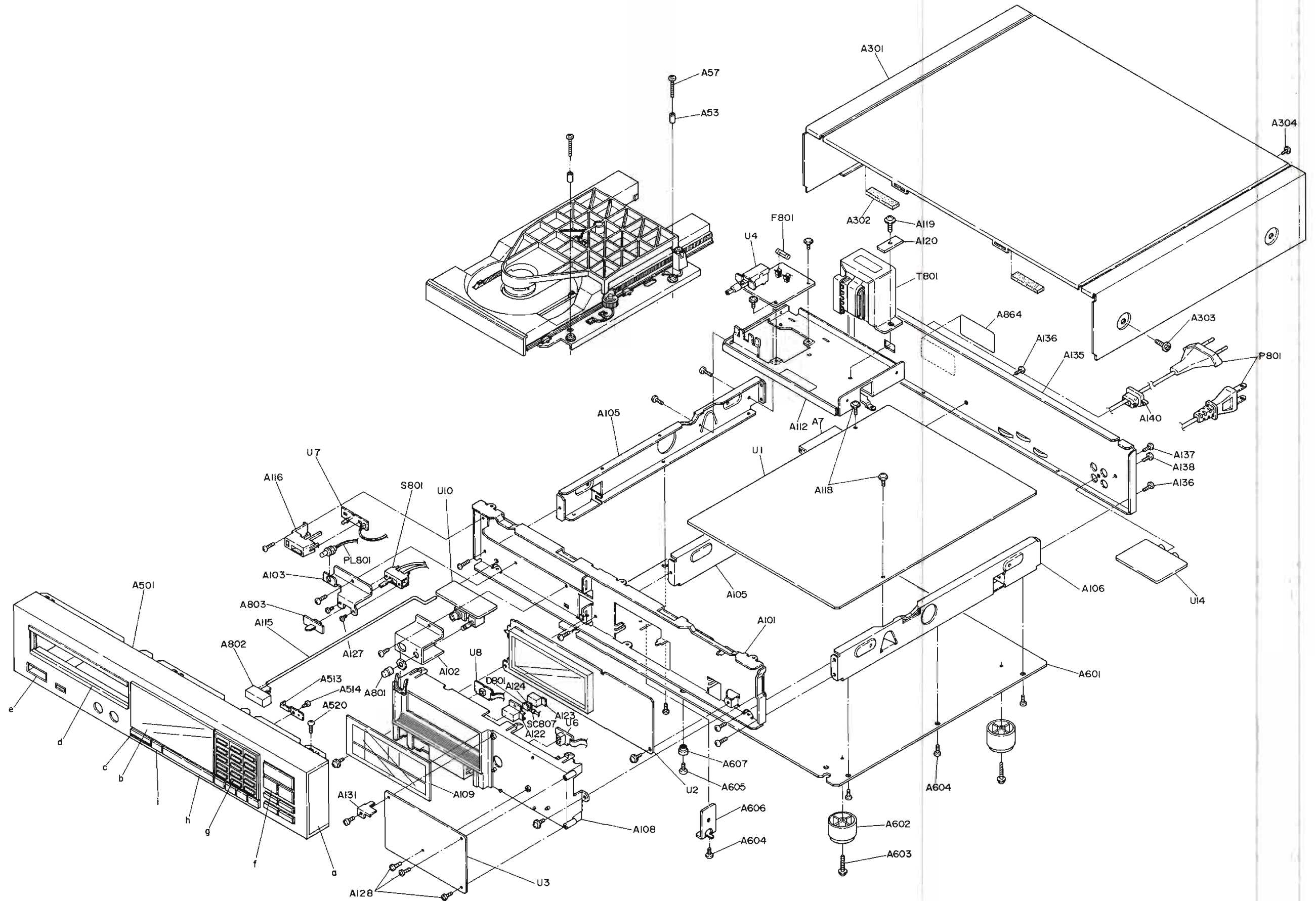

A B C D
MECHANISM EXPLODED VIEW

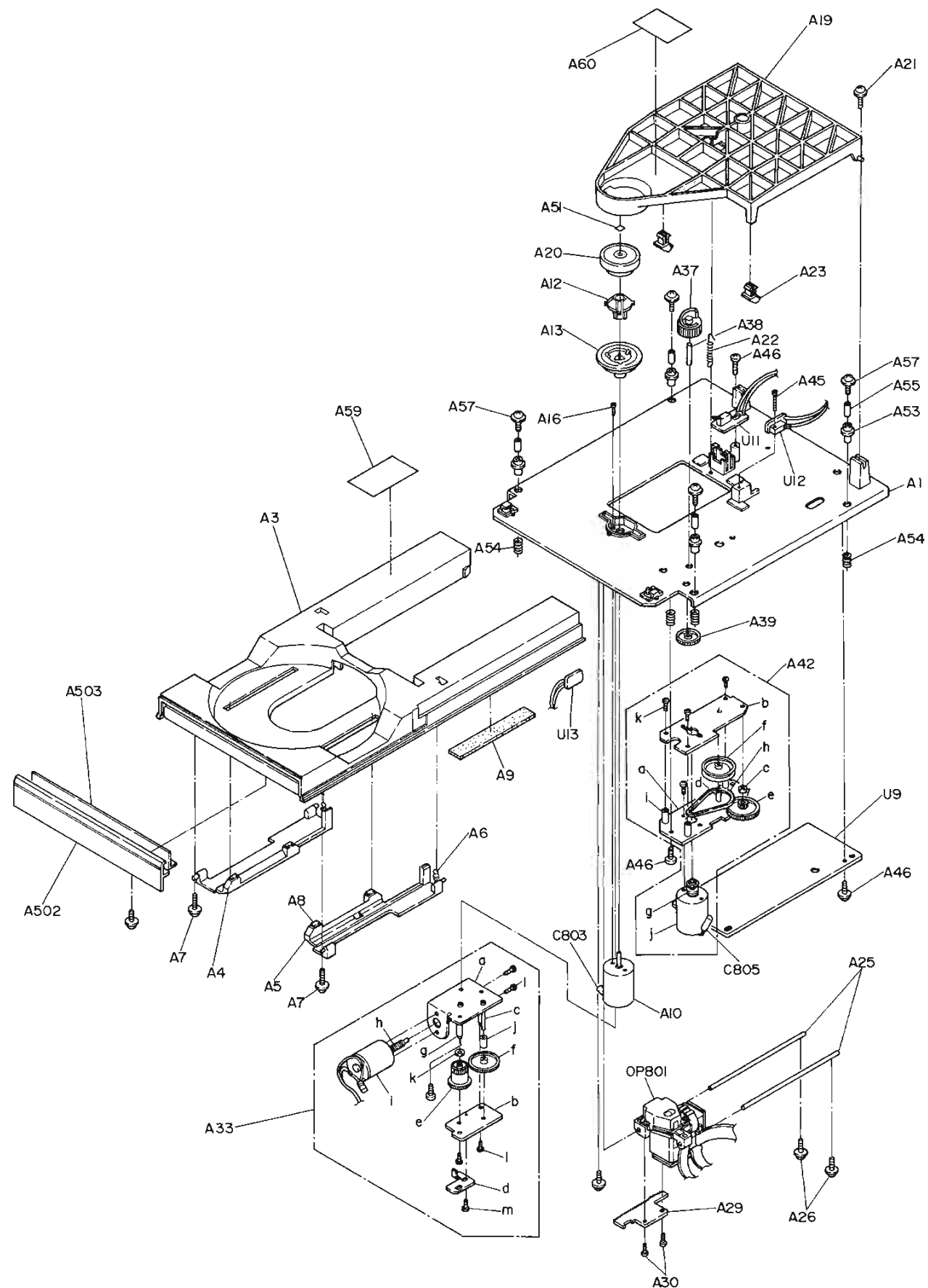
PARTS LIST

REF NO.	PART NO.	DESCRIPTION
A1	27100071C	Chassis M
A3	27300756C	Disc table
A4	28335031B	Lifter lever L
A5	28335032B	Lifter lever R
A6	27180242	Spring
A7	831430088	3TTW + 8P (BC), Tapping screw
A8	28140607	Cushion, protection
A9	28140429	Cushion
A10	24502180	VA-612, Spindle motor
A12	24506703B	Center spindle
A13	27300797	Turntable ass'y
A16	82142003	2P+3F(BC), Pan head screw
A19	27300757B	Arm
A20	28330065A	Cap ass'y
A21	831430100	3TTW+10P(BC), Tapping screw
A22	27180280	Spring
A23	27220035	Nail
A24	87643010	W3 x 10F(BC), Washer
A25	27260175	Shaft, pick-up
A26	831430100	3TTW+10P(BC), Tapping screw
A29	27300809	Rack
A30	82142606	2.6P+6F, Pan head screw
A33	24506687	Gear ass'y, pick-up
A37	27300758A	Cam
A38	27260176	Shaft
A39	27300759	Gear KU
A42	24502179	Tray motor ass'y
A45	833420108	2TTP+10B(BC), Tapping screw
A46	833430080	3TTP+8P(BC), Tapping screw
A47	834430068	3TTS+6B(BC), Tapping screw
A50	28140631	Cushion
A51	29110055	Tape, Teflon
A53	28140608A	Rubber, cushion
A54	2718245-2	Spring
A55	27265118	Ring
A57	831430168	3TTW+16B(BC), Tapping screw
A59	29360806	Label LASER
A60	29360807	Label DANGER
A502	27210593A	Front panel S
A503	27141002	Bracket, tray
C803, C805	352942206	22 μ F, 16V, Non-polar elect. capacitor
OP801	241051	KSS-121B, Optical pick-up
SC801	2000450	NSAS-2P-409, Socket, spindle motor
SC802	2000451	NSAS-2P-410, Socket, slide motor
SC803	2000452	NSAS-2P-417, Socket, open/close switch
SC804	2000453	NSAS-2P-412, Socket, timer switch
SC805	2000460	NSAS-3P-419, Socket
SC806	2000461	NSAS-3P-420, Socket
U9	10408565	NAPRE-2365, Preamplifier pc board ass'y
U11	10408567	NACSW-2367, Close switch pc board ass'y
U12	10408568	NAOSW-2368, Open switch pc board ass'y
U13	10408569	NASSW-2369, Slide switch pc board ass'y

PARTS LIST

REF. NO.	PART NO.	DESCRIPTION	REF. NO.	PART NO.	DESCRIPTION
A101	27110248A	Front bracket	F801	△ 252045	1A(ST-6), Fuse (D)
A102	27140996A	Bracket H	F801	△ 252063	500m A-SE-EAWK, Fuse (G/W/Q)
A103	27140997	Bracket T	F802	△ 252045	1A(ST-6), Fuse (W)
A105	27115181	Side bracket L	PL801	210181	PL14V60mAW4, Lamp
A106	27115182A	Side bracket R	P801	△ 253112	AS-UC-4#18, Power supply cord (D)
A107	28170014	Bushing		△ 253083-1	AS-CEE-250V 2.5 A, Power supply cord (G/W)
A108	27190374A	Holder		△ 728328	2-0.75BS16, Power supply cord (Q)
A109	28133138B	Back plate	P803	△ 25065096	NPF-073, Fuseholder (W)
A112	27130396	Bracket, power transformer	SC801	2000450	NSAS-2P-409, Socket, spindle motor
A115	27260177	Shaft, switch		2000451	NSAS-2P-410, Socket, slide motor
A116	27190376B	Holder LED-CD		2000452	NSAS-2P-417, Socket, open/close switch
A117	834430068	3TTS+6B(BC), Tapping screw	SC804	2000453	NSAS-2P-412, Socket, timer switch
A118	831430088	3TTW+8B(BC), Tapping screw	SC805	2000460	NSAS-3P-419, Socket
A119	830440089	4TTC+8C(BC), Tapping screw	SC806	2000461	NSAS-3P-420, Socket
A120	870065	Washer PT	SC807	2000474	NSAS-3P-433, Socket for D801
A122	27225072	Shielded case A	S801	25065257	NSS-22108, Slide switch, timer
A123	27225073	Shielded case B	S802	△ 25065123	NSS-1258P, Voltage selector switch (W)
A124	28140609	Cushion	T801	△ 230895A	NPT-882D, Power transformer (D)
A127	82142604	2.6P+4F(BC), Pan head screw		△ 230896A	NPT-882G, Power transformer (G)
A128	833430080	3TTP+8P(BC), Tapping screw		△ 230897A	NPT-882DG, Power transformer (W)
A131	27180246A	Spring A, grong		△ 2300042	NPT-882Q, Power transformer (Q)
A135	27120719A	Back panel (D)	U1	10408557	NAMAI-2357, Main circuit pc board ass'y
	27120720	Back panel (G)	U2	10408558	NADIS-2358, Diaplay pc board ass'y
	27120721	Back panel (W)	U3	10408559	NAFSW-2359, Function switch pc board ass'y
	27120777	Back panel (Q)	U4	10408560	NAPSW-2360, Power switch pc board ass'y (D)
A136	834430068	3TTS+6B(BC), Tapping screw		10414560A	NAPSW-2360, Power switch pc board ass'y (G/Q)
A137	833430080	3TTP+8P(BC), Tapping screw		10410560B	NAPSW-2360A, Power switch pc board ass'y (W)
A138	834230108	3TTS+10B(Ni), Nickel screw	U6	10408562	NAMEM-2362, Memory pc board ass'y
A140	△ 27300750	Strainrelief	U7	10408563	NADIN-2363, Disc in indicator pc board ass'y
A141	82143006	3P+6FN(BC), Pan head screw (W)	U8	10408564	NALSW-2364, Loading switch pc board ass'y
A142	834430068	3TTS+6B(BC), Tapping screw (W)	U10	10408566	NAHED-2366, Headphone terminal pc board ass'y
A301	28184283	Top cover	U14	10408584	NAAF-2484, Output terminal pc board ass'y
A302	28140020	40 x 10 x 4, Cushion			
A303	838440089	4TTB+8C(BC), Tapping screw			
A304	834430108	3TTS+10B(BC), Tapping screw			
A501	10408321	Front panel ass'y			
a		End cap			
b		Clear plate			
c		Clear plate CD			
d		Plate			
e		Guide, power			
f		Facet, power			
g		Knob ass'y			
i		Knob ass'y, holder			
A507	28194212A	Bar, decoration			
A510	28400240	Plate			
A514	833426060	2.6TTP+6B(BC), Tapping screw			
A515	28140630	Cushion			
A520	834430068	3TTS+6B(BC), Tapping screw			
A521	833430080	3TTP+8P(BC), Tapping screw			
A601	27170204A	Bottom board			
A602	27175020A	Leg			
A603	831430168	3TTW+16B(BC), Tapping screw			
A604	834430068	3TTS+6B(BC), Tapping screw			
A605	831430100	3TTW+10P(BC), Tapping screw			
A801	28322155	Knob, level			
A802	28322099	Knob, power			
A803	28322100	Knob, timer			
D801	226022	PH302B, Photo diode			

Note: (D): Only 120V model
(G): Only 220V model
(W): Only Universal model
(Q): Only 240V model

NOTE: THE COMPONENTS IDENTIFIED BY MARK △ ARE CRITICAL FOR RISK OF FIRE AND ELECTRIC SHOCK. REPLACE ONLY WITH PARTS NUMBER SPECIFIED.

PRINTED CIRCUIT BOARD VIEW FROM BOTTOM SIDE

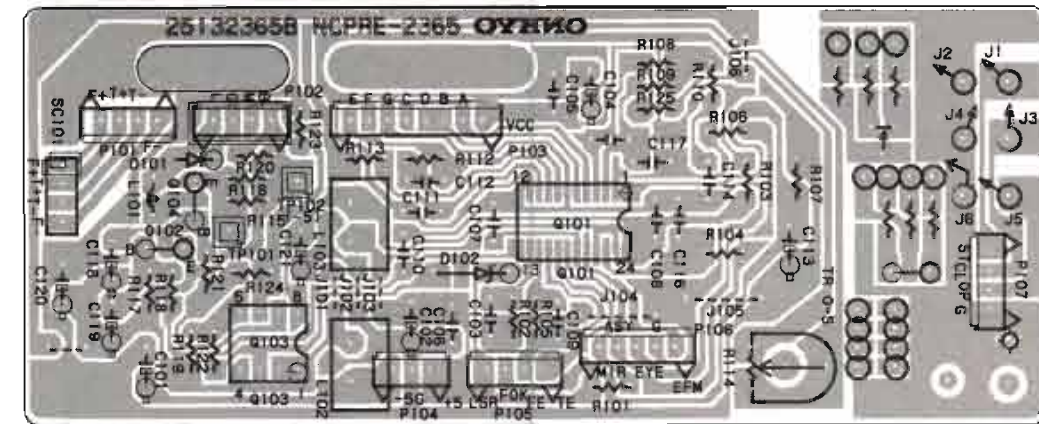

PREAMPLIFIER PC BOARD

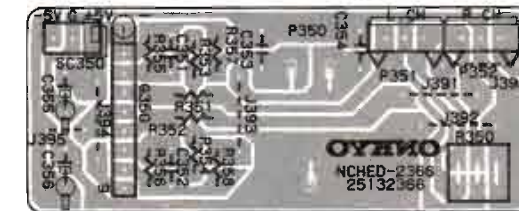

HEADPHONE TERMINAL PC BOARD

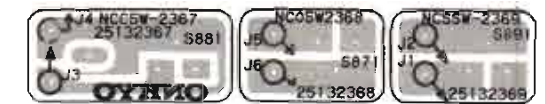
CLOSE SWITCH PC BOARD
OPEN SWITCH PC BOARD
SLIDE MOTOR SWITCH PC BOARD

PREAMPLIFIER PC BOARD (NAPRE-2365)

CIRCUIT NO.	PART NO.	DESCRIPTION
		ICs
Q101	222886	CX-20109
Q103	222465	NJM4558D
		Transistors
Q102	2211254 or 2211255	2SC1815 (Y) or 2SC1815 (GR)
Q104	2211654 or 2211653	2SC2235 (Y) or 2SC2235 (O)
		Diodes
D101	223155	1SS138
D102	2239533	RD7, 5EB3
		Coil
L101	231023	NCH-1062
		Filters
L102, L103	231054	NCH-5095
		Capacitors
C102	352721019	100μF, 6.3V, Elect.
C104	352734709	47μF, 10V, Elect.
C113	352784799	0.47μF, 10V, Elect.
C118, C119	352721019	100μF, 6.3V, Elect.
C120, C121	352734709	47μF, 10V, Elect.
		Resistor
R114	5215048M	N08HR200KBC, Semi-fixed
		Plugs
P101, 102	25055134	NPLG-4P-118
P103	25055138	NPLG-8P-122
P104	25055136	NPLG-3P-117
P105, P107	25055134	NPLG-4P-118
P106	25055139	NPLG-5P-119
		Socket
SC101	2000454	NSAS-4P-413

HEADPHONE TERMINAL PC BOARD (NAHED-2366)

CIRCUIT NO.	PART NO.	DESCRIPTION
Q350	222887	NJM4556S, IC
C355, C356	352734709	47μF, 10V, Elect. capacitors
R350	5104172A	N09RGL20KB15, Variable resistor, headphone level
P350	25045139	HJL-0540-01-010; Headphone terminal
SC350	2000462	NSAS-3P421, Socket
P351, P352	25055133	NPLG-3P-117, Plugs

CLOSE SWITCH PC BOARD (NACSW-2367)

CIRCUIT NO.	PART NO.	DESCRIPTION
S881	25064260	NMS-1211, microswitch

OPEN SWITCH PC BOARD (NACSW-2368)

CIRCUIT NO.	PART NO.	DESCRIPTION
S871	25065260	NMS-1211, microswitch

SLIDE MOTOR SWITCH PC BOARD (NASSW-2369)

CIRCUIT NO.	PART NO.	DESCRIPTION
S891	25065261	NMS-1212, microswitch

PRINTED CIRCUIT BOARD VIEW FROM BOTTOM SIDE

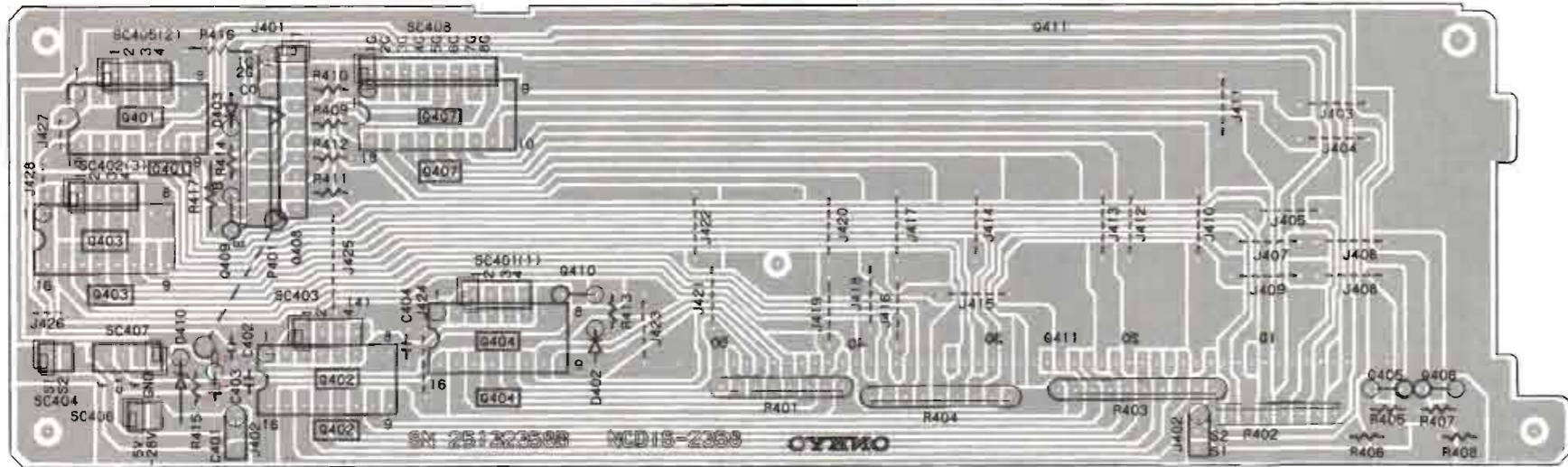

DISPLAY PC BOARD

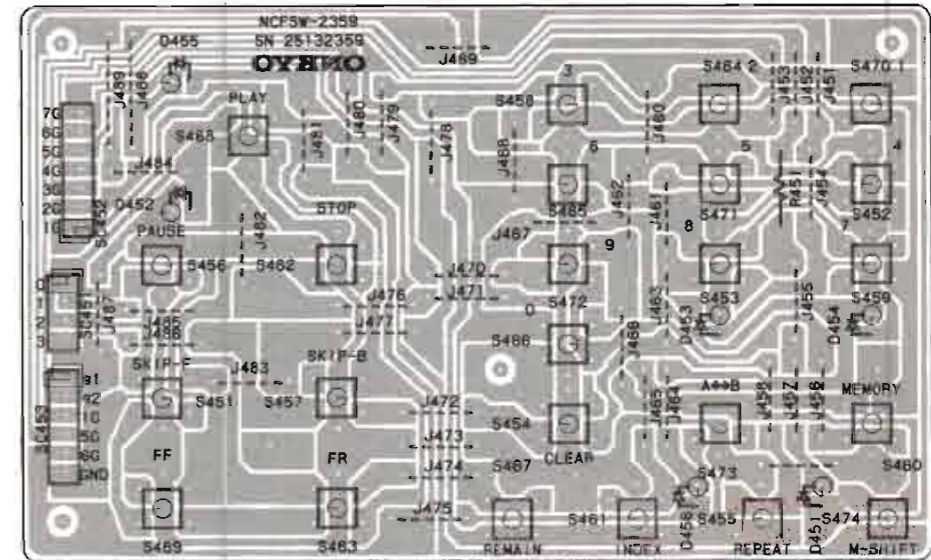

FUNCTION SWITCH PC BOARD

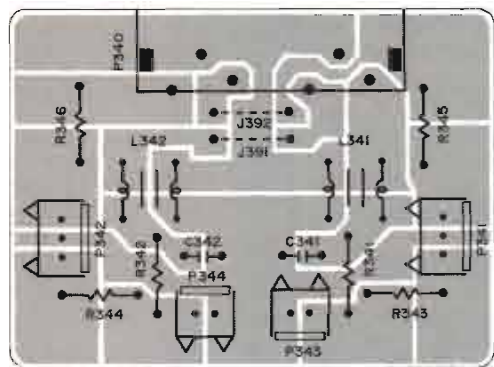

OUTPUT TERMINAL PC BOARD

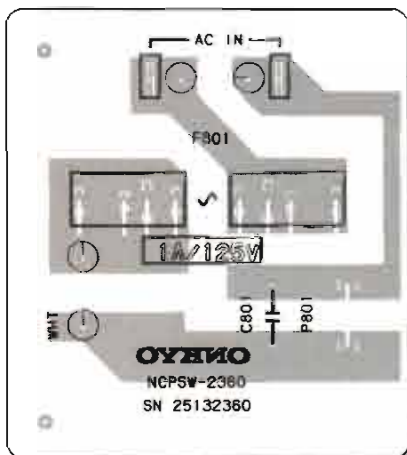

POWER SWITCH PC BOARD



MEMORY PC BOARD



DISC IN INDICATOR PC BOARD



LOADING SWITCH PC BOARD

PRINTED CIRCUIT BOARD PARTS LIST

POWER SWITCH PC BOARD (NAPSW-2360/A/B)

CIRCUIT NO.	PART NO.	DESCRIPTION
C801	3500065A	△DE7150FZ103PAC400/125V, Capacitor IS
S801	25035382	△NPS-111-346P, Power switch
	250113	△SNS051, Fuseholder (D/W)
	25050065	△YSH403T, Fuseholder (G)
F801	252045	△1A (ST-6), Fuse (D/W)
	252063	△0.5A-SE-EAK, Fuse (G)
C801a	27300601	△SB1925CSB, Cover, capacitor
	29360384	T500mA/250V, Label, fuse, rating (G/W)
	28320135	Cnector, push switch

FUNCTION SWITCH PC BOARD (NAFSW-2359)

CIRCUIT NO.	PART NO.	DESCRIPTION
D451-D454	225177	GL-3PR28, L.E.Ds
D455	225179	GL-3NG28, L.E.D
D456	225177	GL-3PR28, L.E.D
S451-S474	25035291	NPS-111S257, Push switches
SC451	2000471	NSAS-4P430, Socket
SC452	2000472	NSAS-7P431, Socket
SC453	2000473	NSAS-6P432, Socket
	27190379	Holder LED-P
	27190377	Holder, L.E.D

DISPLAY PC BOARD (NADIS-2358)

CIRCUIT NO.	PART NO.	DESCRIPTION
Q401-Q404	222757	TC5069BP
Q407	222750	HA16619P
Q411	212022	Fluorescent indicator tube 24ST-01ZK
Q405, Q406	2211454 or 2211455	2SA1015(Y) or 2SA1015(GR)
Q408	2212660	TA64, Array
Q409, Q410	2211254 or 2211255	2SC1815(GR) or 2SC1815(Y)

CIRCUIT NO.	PART NO.	DESCRIPTION
D401	2239513	RD6.8EB3
D402, D403	223155	1SS138
C401	353721019	100μF, 6.3V, Electrolytic
R401, R402	49121104407	100kΩ x 7, 1/8W, Network
R403, R404	49121104408	100kΩ x 8, 1/8W, Network
P401	25055136	NPLG-6P-120
SC401	2000463	NSAS-4P-422
SC402	2000464	NSAS-4P-423
SC403	2000465	NSAS-4P-424
SC404	2000466	NSAS-2P-425
SC405	2000467	NSAS-4P-426
SC406	2000468	NSAS-2P-427
SC407	2000469	NSAS-4P-428
SC408	2000470	NSAS-8P-429
Cushion	28140622	40 x 10 x 4.5

OUTPUT TERMINAL PC BOARD (NAAF-2484)

CIRCUIT NO.	PART NO.	DESCRIPTION
L341, L342	231066	NCH-1118, Coils
C341, C342	372522214	220pF±5%, 50V, Styrol capacitors
P340	25045142	NPJ-4PD-BL55, Output terminal
P341, P342	25055133	NPLG-3P-117, Plugs
P343, P344	25055132	NPLG-2P-116, Plugs

MEMORY PC BOARD (NAMEM-2362)

CIRCUIT NO.	PART NO.	DESCRIPTION
D841, D842	225177	GL-3PR28, L.E.Ds
	27190378	Holder

DISC IN INDICATOR PC BOARD (NADIN-2363)

CIRCUIT NO.	PART NO.	DESCRIPTION
D851	225179	GL3NG28, L.E.D
SC851	2000475	NSAS-3P434, Socket Holder
	27190173	

LOADING SWITCH PC BOARD (NALSW-2364)

CIRCUIT NO.	PART NO.	DESCRIPTION
S861	25035291	NPS-111S257, Push switch
SC861	2000476	NSAS-3P435, Socket

(D) : Only 120V model
 (G) : Only 220V and 240V models
 (W) : Only Universal model

NOTE: THE COMPONENTS IDENTIFIED BY MARK △ ARE CRITICAL FOR RISK OF FIRE AND ELECTRIC SHOCK. REPLACE ONLY WITH PARTS NUMBER SPECIFIED.

PRINTED CIRCUIT BOARD VIEW FROM BOTTOM SIDE

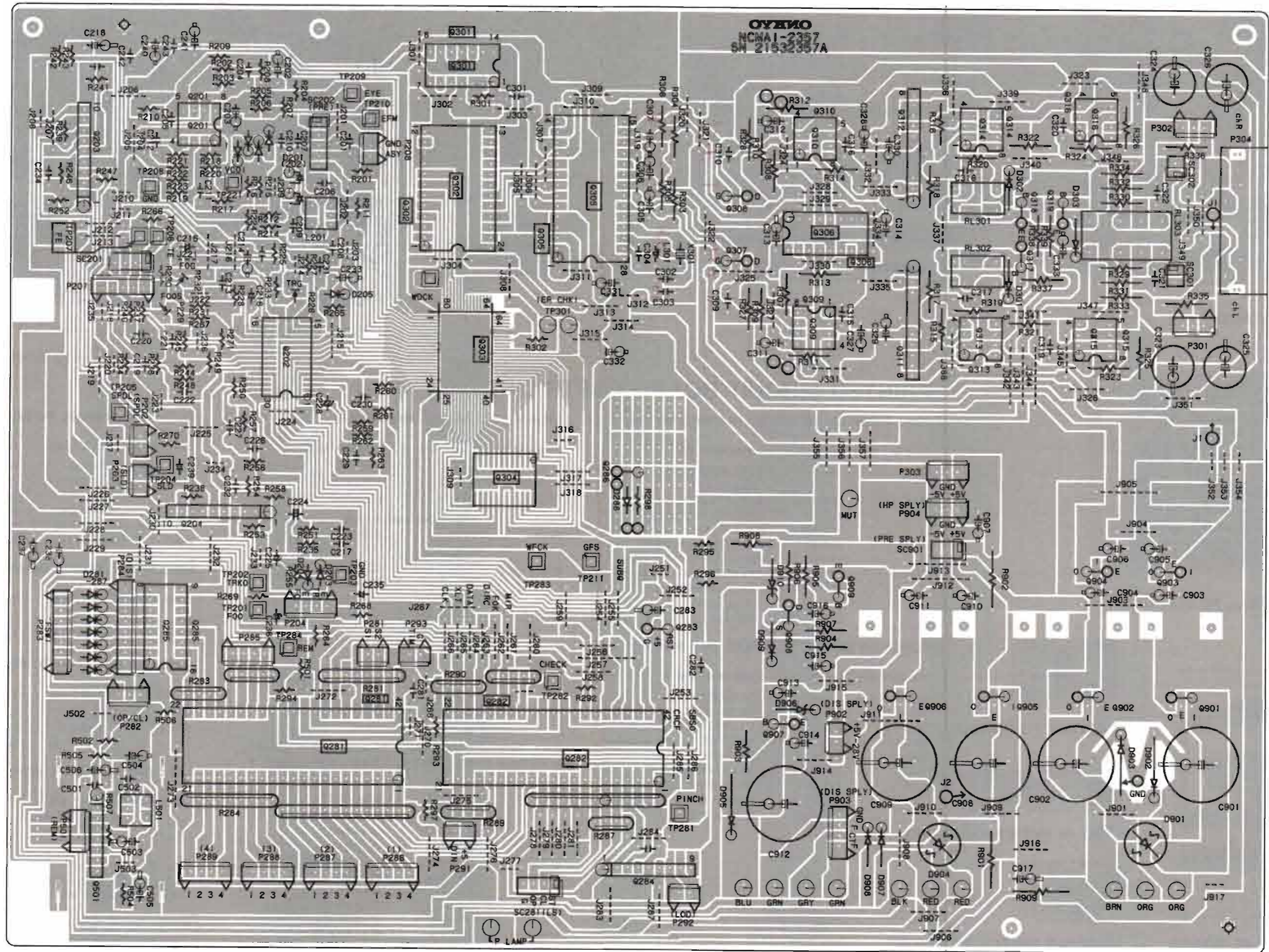

CONNECTION DIAGRAM

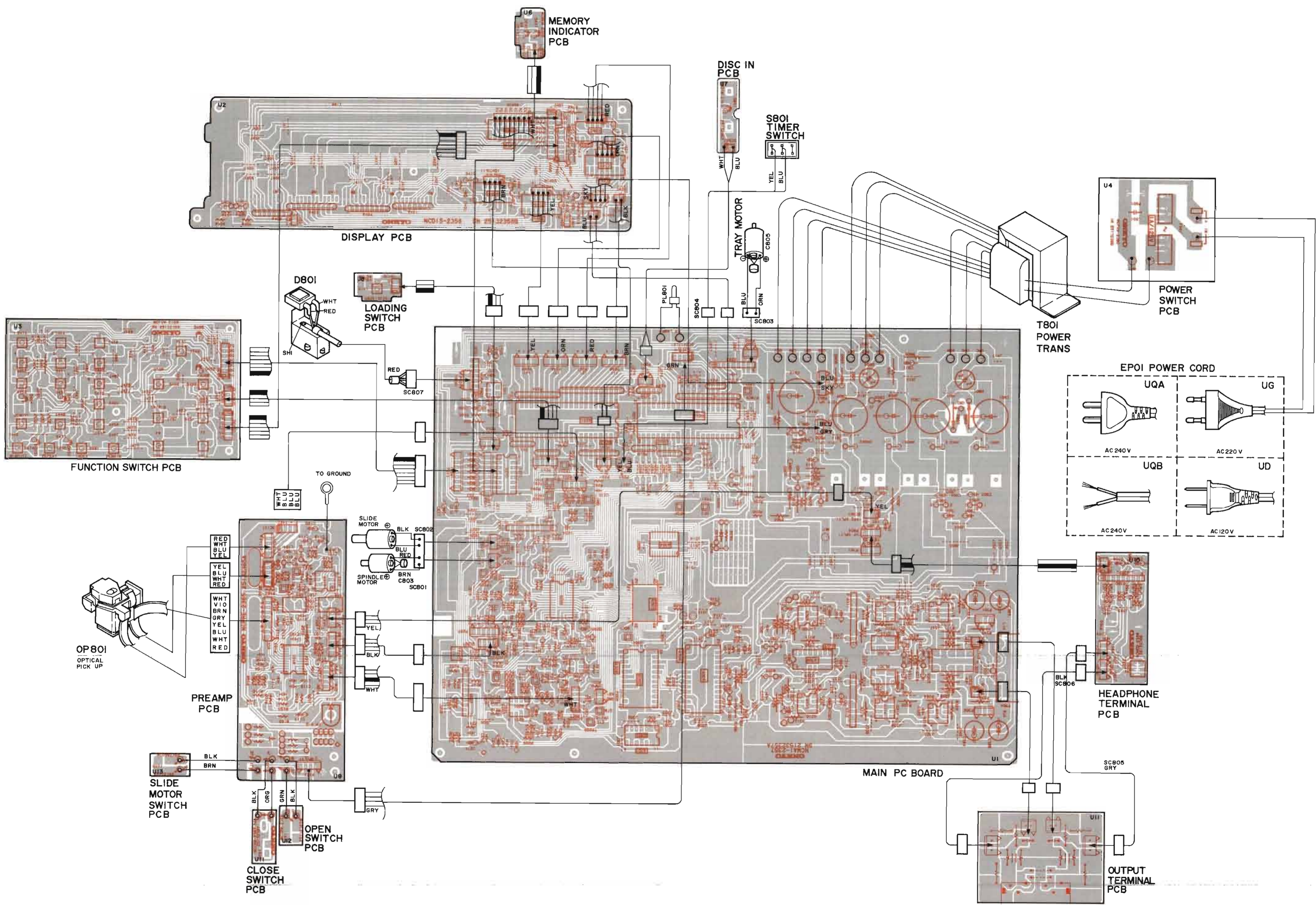

SCHEMATIC DIAGRAM

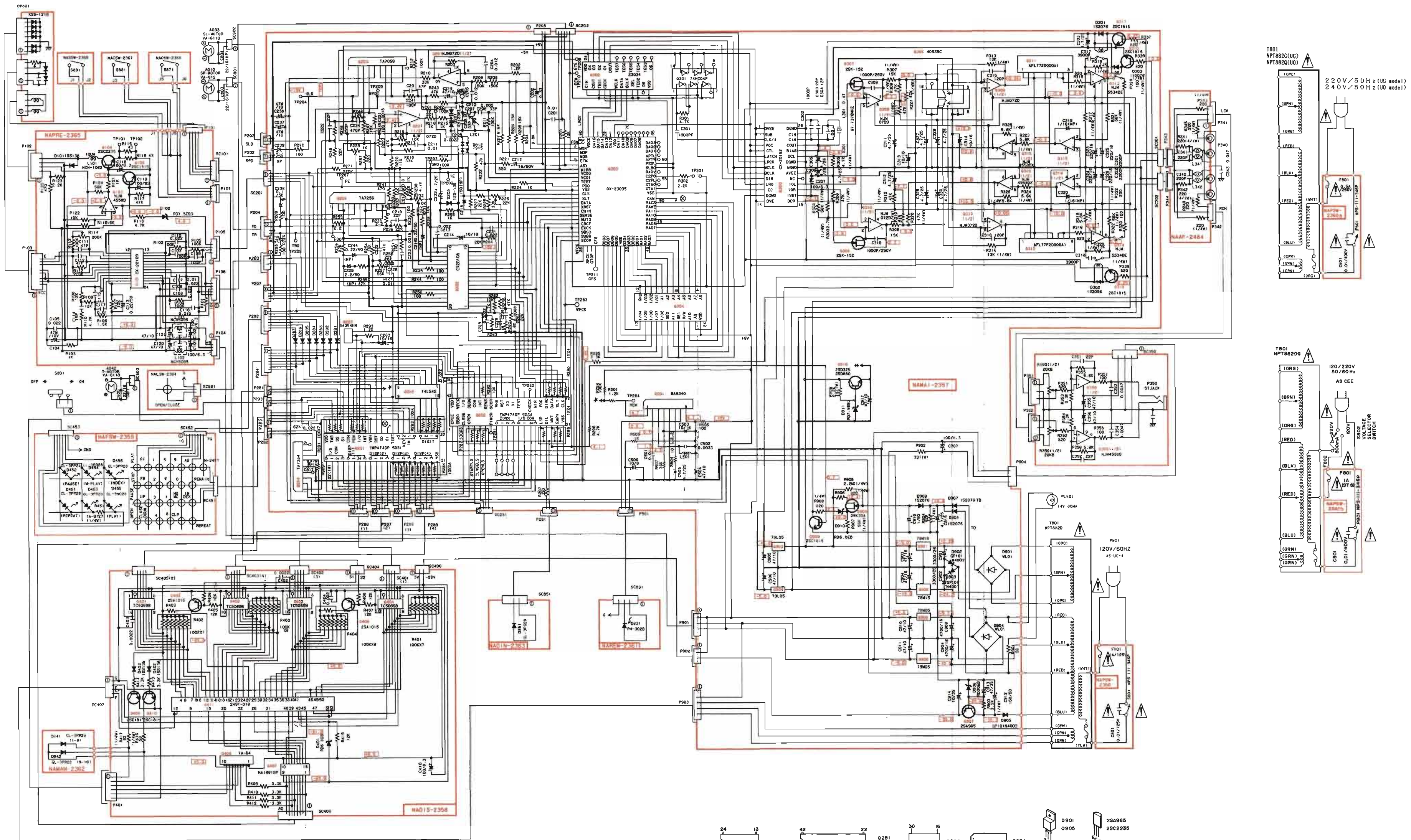

CAUTION:

COMPONENTS IDENTIFIED BY MARK Δ ON THE SCHEMATIC DIAGRAM AND IN THE PARTS LIST ARE CRITICAL FOR RISK OF FIRE AND ELECTRIC SHOCK. REPLACE THESE COMPONENTS WITH ONKYO PARTS WHOSE PART NUMBERS APPEAR AS SHOWN IN THIS MANUAL.

NOTES:

- + ALL RESISTORS ARE IN OHMS 1/6 WATT UNLESS OTHERWISE NOTED
- + ALL CAPASITORS ARE IN μF, 50VW UNLESS OTHERWISE NOTED.
- + ELECTROLYTIC CAPASITORS (⊥) ARE IN μF/WV.
- + VOLTAGE (MEASURED WITH V. T. V. M.) NO INPUT SIGNAL.
- + CIRCUIT IS SUBJECT TO CHANGE FOR IMPROVEMENT.

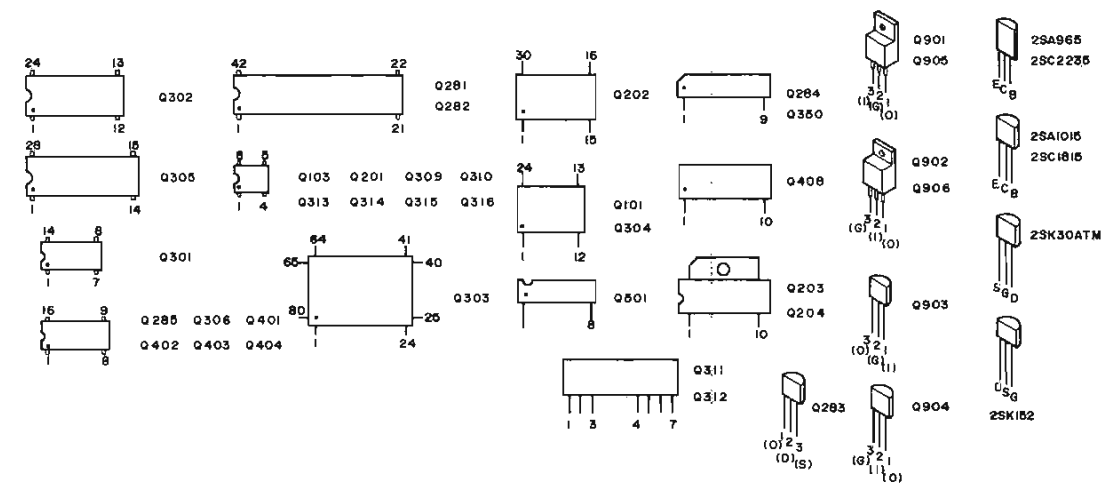

PRINTED CIRCUIT BOARD PARTS LIST

CIRCUIT NO.	PART NO.	DESCRIPTION	CIRCUIT NO.	PART NO.	DESCRIPTION
	ICs			Capacitors	
Q201	222465	NJM4558D	C202	352783399	0.33μF, 50V, Elect.
Q202	222875	CX20108	C212	352780109	1μF, 50V, Elect.
Q203, Q204	222825	TA7256P	C214	352741009	10μF, 16V, Elect.
Q281	222877	TMP4740P-5031	C215	352940106	1μF, 16V, Non-polar Elect.
Q282	222888	TMP4740P-5034	C216	352982296	0.22μF, 50V, Non-polar Elect.
Q283	222878	S8054HN	C218	352734709	47μF, 10V, Elect.
Q284	222826	TA7354P	C224	352982296	0.22μF, 50V, Non-polar Elect.
Q285	222740421	74LS42P	C225	352940226	2.2μF, 16V, Non-polar Elect.
Q301	222755	TC74HCU04P	C228	352980336	3.3μF, 50V, Non-polar Elect.
Q302	222880	CX23034	C233	352750479	4.7μF, 25V, Elect.
Q303	222881	CX23035	C235, C236	352981096	0.1μF, 50V, Non-polar Elect.
Q304	222882	HM6116FP4	C237, C238	352744709	47μF, 16V, Elect.
Q305	222883	CX20152	C239	352981096	0.1μF, 50V, Non-polar Elect.
Q306	222717	μPD4053BC	C283	352741009	10μF, 16V, Elect.
Q309, Q310	222884	NJM072DE	C284	352780109	1μF, 50V, Elect.
Q311, Q312	222047	AFL77F20000A1	C305, C306	352750479	4.7μF, 25V, Elect.
Q313, Q314	222762	NJM5534DD	C307	352721019	100μF, 6.3V, Elect.
Q315, Q316	222585	NJM4558DXB	C309, C310	3700006	1,000pF±5%, 250V, Styrole
Q501	222906	BA-6340	C311, C312	352750479	4.7μF, 25V, Elect.
Q901	222780151	78M15	C313, C314	352754109	10μF, 6.3V, Elect.
Q902	222790151	79M15	C315, C316	372521214	120pF±5%, 50V, Styrole
Q903	222780053	78L05	C317, C318	372523924	3,900pF±5%, 50V, Styrole
Q904	222790053	79L05	C319, C320	352940106	1μF, 16V, Non-polar
Q905	222780052	78M05	C323-C326	352742219	220μF, 16V, Elect.
Q906	222790052	79M05	C327-C330	352750479	4.7μF, 25V, Elect.
	Transistors		C331, C332	352734709	47μF, 10V, Elect.
Q286	2211454 or 2211455	2SA1015 (GR) or 2SA1015 (Y) (Abolition after 2100 p'cs.)	C333	352750479	4.7μF, 25V, Elect.
Q307, Q308	2212383 or 2212384	2SK152-3 or 2SK152-4	C503	352721019	100μF, 6.3V, Elect.
Q317-Q319	2211255	2SC1815 (GR)	C504	352734709	47μF, 10V, Elect.
Q907	2211643 or 2211644	2SA965 (O) or 2SA965 (Y)	C505	352750479	4.7μF, 25V, Elect.
Q908	2212375	2SK30ATM (GR)	C506	352741009	10μF, 16V, Elect.
Q909	2211254 or 2211255	2SC1815 (Y) or 2SC1815 (GR)	C901, C902	352743329	3,300μF, 25V, Elect.
Q910	2201074 or 2201035	2SD880 (Y) or 2SD325 (E)	C903, C904	352744709	47μF, 16V, Elect.
	Diodes		C905, C906	352734709	47μF, 10V, Elect.
D201, D202	223157	KV-1236Z	C907	352721019	100μF, 6.3V, Elect.
D205, D287	223155	1SS138	C908, C909	352744729	4,700μF, 16V, Elect.
D281-D285	223155	1SS138	C910, C911	352734709	47μF, 10V, Elect.
D286	223155	1SS138 (Add after 2101 p'cs.)	C912	352781529	1,500μF, 50V, Elect.
D301-D303	223145 or	1S2076TD or	C913	352764709	47μF, 35V, Elect.
D907-D909	223150	US1040	C914	352761009	10μF, 35V, Elect.
D901, D904	223862	WL-01	C915	352750479	4.7μF, 25V, Elect.
D902, D903	223880	GP101N4003	C916	352780109	1μF, 50V, Elect.
D905	223880	GP101N4003	C917	352744709	47μF, 16V, Elect.
D906	2239811	RD30EB1	Resistors		
D910	2239513	RD6.8EB3	R226	5210015	N06HR22KBDM, Semi-fixed
D911	2239533	RD7.5EB3	R229	5210007	N06HR1KBDM, Semi-fixed
D912-D915	223155	1SS138	R232	5210013	N06HR10KBDM, Semi-fixed
D288			R281	49121103407	10kΩ x 7, 1/8W, Network
	Coils		R283	49121103404	10kΩ x 4, 1/8W, Network
L201	232122	NSO-4038	R284	49121103408	10kΩ x 8, 1/8W, Network
L301	233345	NCH-1115	R287	49121331403	330Ω x 3.1/8W, Network
L501	232123	NMC-4052	R289, R290	49121102404	1kΩ x 4, 1/8W, Network
	X'tal		R901	441625604	56Ω, 1W, Metal oxide film
X301	3010093	KD4224FDA	R902	441623304	33Ω, 1W, Metal oxide film
			Plugs		
			P202-P204	25055132	NPLG-2P-116
			P206	25055134	NPLG-4P-118
			P208, P281	25055132	NPLG-2P-116
			P282	25055133	NPLG-3P-117
			P283	25055137	NPLG-7P-121
			P284	25055138	NPLG-8P-122
			P285-P289	25055134	NPLG-4P-118

CIRCUIT NO.	PART NO.	DESCRIPTION	CIRCUIT NO.	PART NO.	DESCRIPTION
	Plugs			Relaies	
P291-P293	25055132	NPLG-2P-116	RL301, RL302	25065258	NRL-1P0. 5ADC05-33
P501	25055133	NPLG-3P-117	RL303	25065259	NRL-2P1. 25ADC05-34
P902	25055132	NPLG-2P-116		Radiators	
P903	25055134	NPLG-4P-118		27160029	RAD-07, White
P904	25055133	NPLG-3P-117		27160151	RAD-54, Black
	Sockets			Screws	
SC201	2000457	NSAS-4P-416		82143006	3P+6FN(BC), Pan head
SC202	2000456	NSAS-5P-415		Shielded plate	
SC203	2000459	NSAS-4P-418		27150203	
SC901	2000458	NSAS-3P-417			
SC301	2000509	NSAS-2P-465			
SC302	2000510	NSAS-2P-466			

ONKYO CORPORATION

International Division: No. 24 Mori Bldg., 23-5, 3-chome, Nishi-Sinbashi, Minato-ku, Tokyo, Japan
 Telex: 2423551 ONKYO J. Phone: 03-432-6981

ONKYO U.S.A. CORPORATION

200 Williams Drive, Ramsey, N.J. 07446 Tel. 201-825-7950

A507 Printed in Japan